



Extend the Renault MEGANE R.S. 300 TROPHY experience  
at [www.renault.com.my](http://www.renault.com.my)



# New Renault MEGANE R.S. 300 TROPHY

Every precaution has been taken to ensure that this publication is accurate and up to date on the date it is printed. This document has been created on the basis of pilot lots and prototypes. In line with its policy of continuous product improvement, Renault reserves the right to modify the specifications, vehicles and accessories described and shown at any time. Such modifications shall be communicated to Renault dealers as quickly as possible. According to the country of sale, certain versions may differ and certain equipment may be unavailable (as standard, on option or as an accessory). Please contact your nearest dealer for the latest information. For printing reasons, the colours that appear in this document may differ slightly from the actual paint and upholstery colours. All rights reserved. The reproduction in any format and by any means of all or part of this publication, without prior written authorisation from Renault, is prohibited.

**TC EURO CARS SDN BHD** (113605-D)  
(A wholly-owned subsidiary of Tan Chong Motor Holdings Berhad)

   [renault.com.my](http://renault.com.my)

03/21







**EVERYDAY  
JUST GOT  
MORE EXHILARATING**



**GREATER  
PERFORMANCE &  
SPORTIER DESIGN**







## ***A SPORTS COCKPIT***

- 1** Exclusive carbon grey setting
- 2** Driver's information display
- 3** Aluminium pedal and footrest
- 4** High performance materials
- 5** R.S. leather steering wheel with paddle shifters



Local specifications may differ.





1.

## EFFICIENCY AND PERFORMANCE

New Renault MEGANE R.S. 300 TROPHY benefits from all the innovations introduced with Megane R.S. such as the 4CONTROL four-wheel steering system.

### 1. Suspension with hydraulic compression stops:

Borrowed from the demanding world of rallying, hydraulic compression stops on the Megane R.S. are added to each shock absorber to dampen the bump before they reach full compression. This avoids any rebound and pendulum effects, helping to keep each tyre in contact with the ground to produce notable improvement, whatever the road throws at you.

### 2. Torsen® mechanical limited slip differential:

Associated with the Cup chassis, it has an asymmetrical transfer rate for acceleration and deceleration to improve acceleration power and cornering speed.

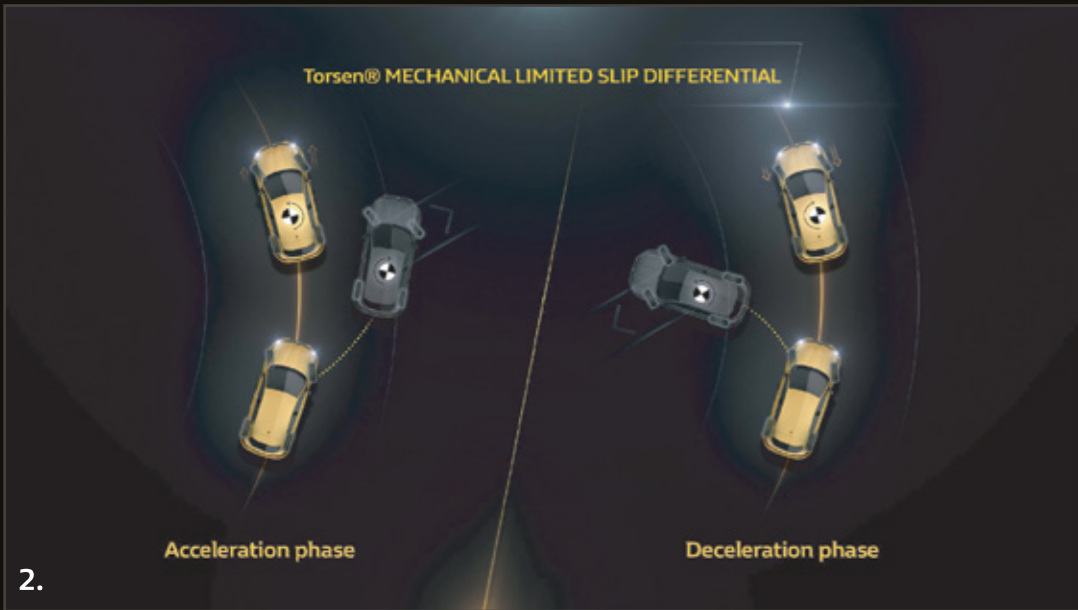

2.

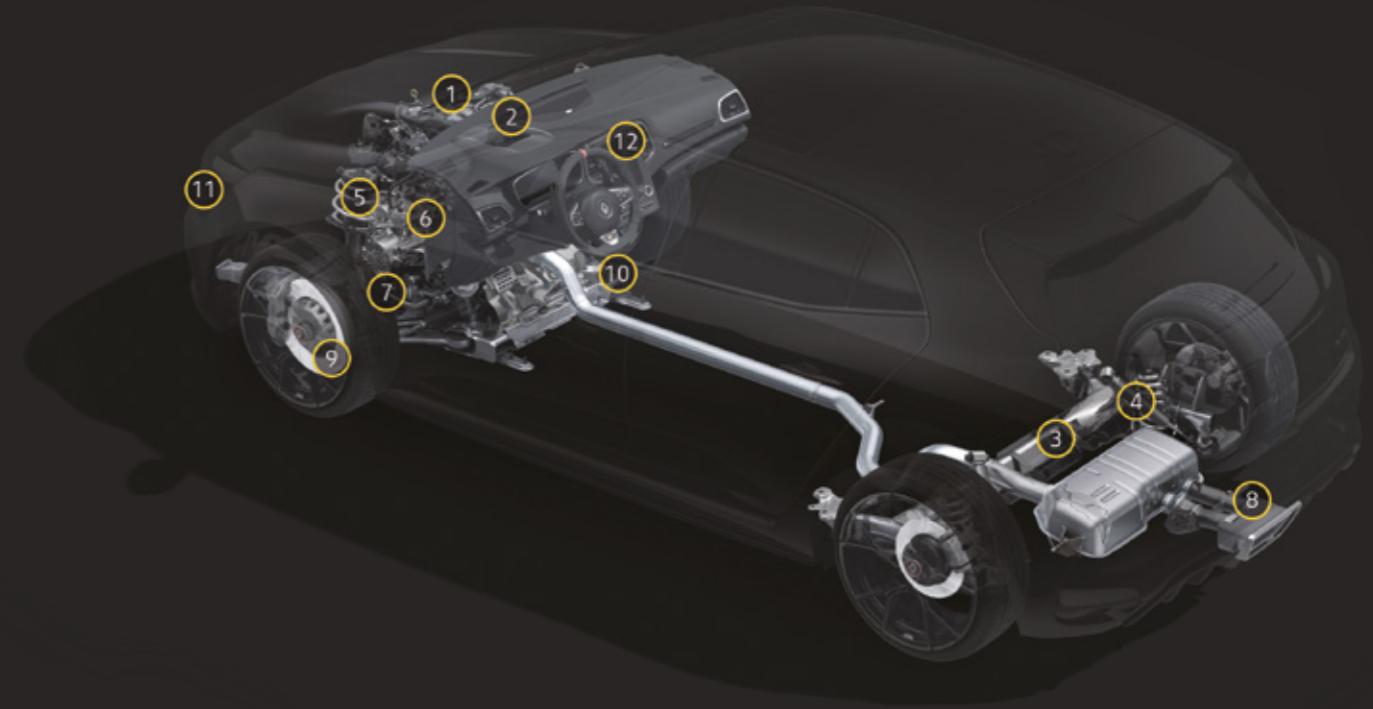

1 1.8L Turbo engine 300 PS/420 Nm

2 Turbocharger with turbine mounted on ceramic ball bearing

3 4CONTROL four-wheel steering system

4 Cup chassis

5 Hydraulic compression stops

6 Torsen® mechanical limited slip differential

7 Front double-axis strut system

8 Valve exhaust system

9 Dual-material brake discs and Brembo® brake callipers

10 EDC automatic gearbox with dual clutch

11 R.S. Vision system



# TECHNOLOGY CONTRIBUTING TO PERFORMANCE

300 PS / 420 Nm / 5.7s from 0 to 100km/h



## MORE POWER

New Renault Megane R.S. 300 TROPHY introduces a new version of the 1.8L turbo engine, driven by 300 PS thanks to development in the turbo and exhaust, notably benefiting from technology pulled directly from Formula 1®.

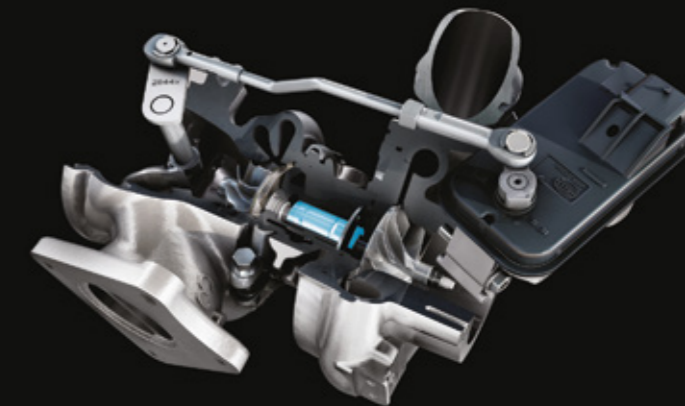

Turbo with ceramic ball bearings

The turbocharger's turbine is now mounted on ceramic ball bearings, for shorter response time.

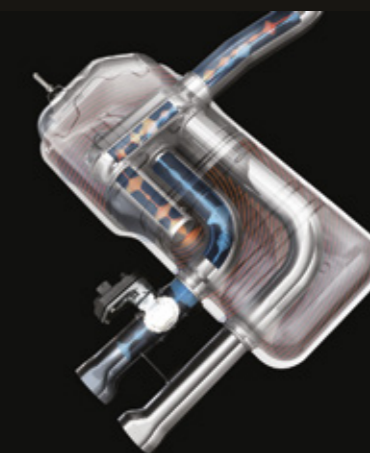

Valve exhaust system

The dual sound exhaust valve system contributes to maximizing engine performance. A valve system - actuated automatically depending on the driving mode selected via the R.S. Drive - offers a double sound. The position of the valve, controlled by the R.S. Drive mode, the engine speed and load, provides two tones: when open, the valve causes reduced flow resistance, enabling the gases to be routed along a more direct path. This allows the engine's sporty and acoustic potential to be fully expressed.



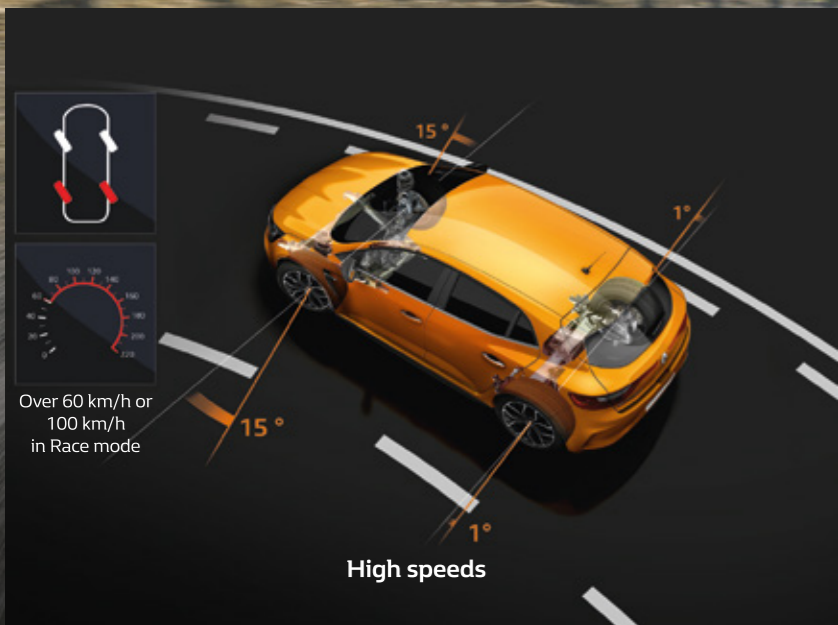
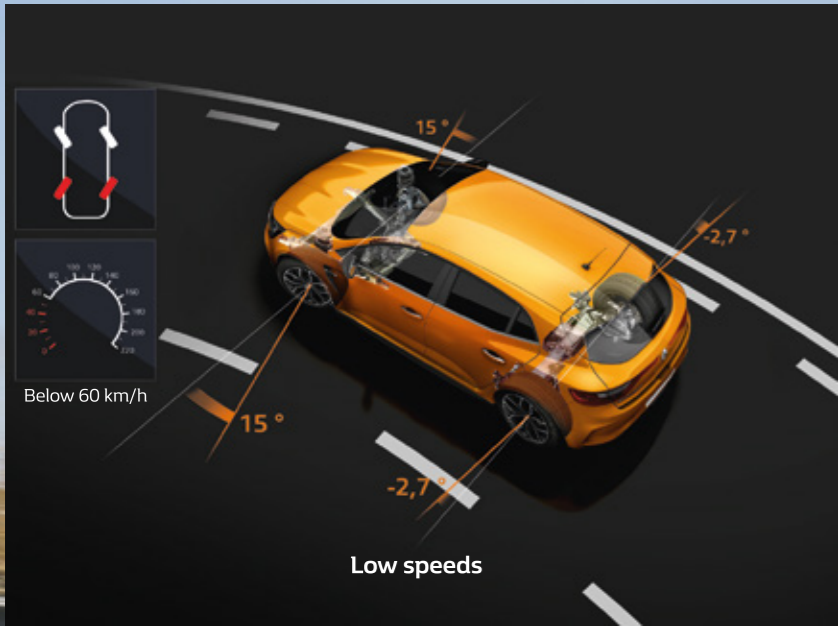

## AGILITY AND STABILITY

4CONTROL technology contributes to incisive steering and optimised roadholding for a precise, surefooted drive. At low speeds, the system turns the rear wheels in the opposite direction to the front wheels. At speeds of over 60 km/h (100 km/h in Race mode), all four wheels turn in the same direction. You are in control of the roads.

## LAUNCH CONTROL

STEP 1



RENAULT SPORT

STEP 2



RENAULT SPORT

STEP 3



RENAULT SPORT







**HIGH PRECISION  
DRIVING**



Orange Tonic (Cost option)



Liquid Yellow (Cost option)



Flame Red



Pearl White



Diamond Black

CARLAB  
Chrome Zone

Local specifications may differ.





Dimensions (mm)

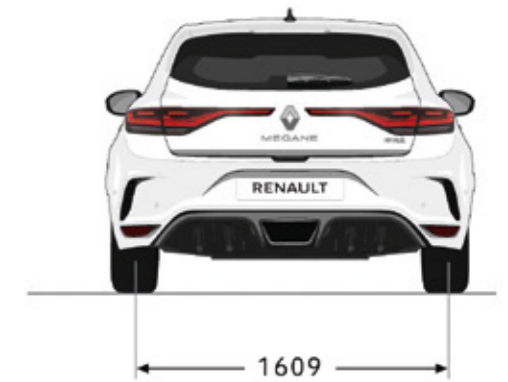
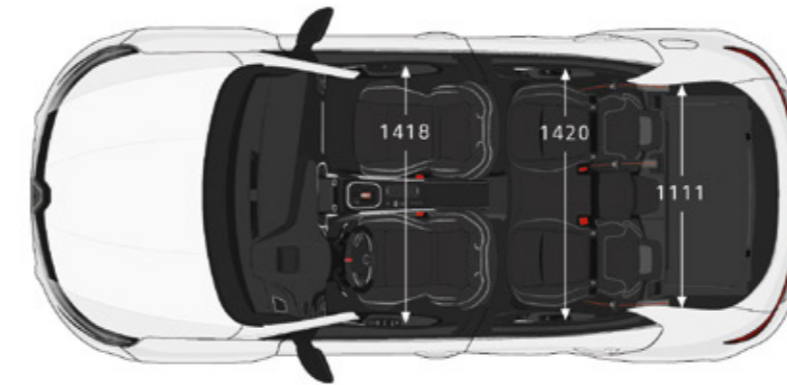
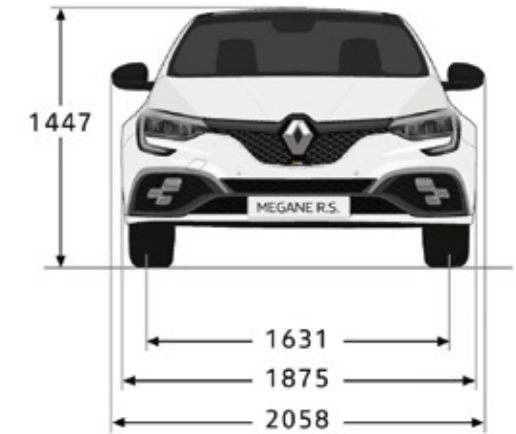
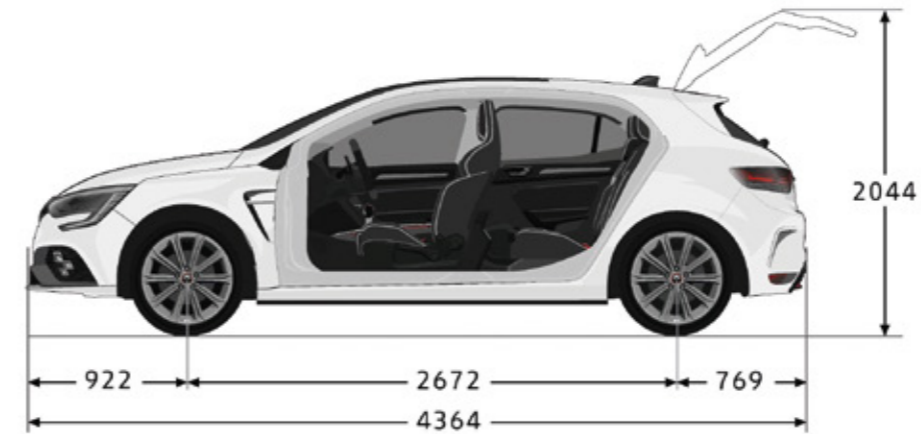





## CARLAB Specifications

ENGINES	R.S. 300 TROPHY EDC AT
Engine type	4-cylinder turbo direct injection
Capacity (cm <sup>3</sup> )	1,798
Bore x stroke (mm)	79.7 x 90.1
Number of cylinders / valves	4 / 16
Peak power (kW/PS) at max. power rating (rpm)	221kW / 300 PS at 6,000rpm
Max. torque (Nm) at power rating (rpm)	420Nm at 3,200rpm
GEARBOX	
Gearbox type	Dual-clutch EDC gearbox
Numbers of gears	6
PERFORMANCE	
Top speed (km/h)	255
1,000 m standing start (s)	24.8
Acceleration 0 -100 km/h (s)	5.7
Acceleration 80 -120 km/h (s)	3.1
FUEL CONSUMPTION AND EMISSIONS	
Combined cycle (L/100km)	8.3
CO <sub>2</sub> (g/km)	189
Fuel tank (l)	49.7
STEERING	
Electrical power steering	•
R-EPS mechanical steering system and assisted rack and pinion	•
Turning cycle, kerb to kerb (m)	10.3
BRAKING	
Front ventilated discs (mm)	355
Rear solid discs (mm)	290
Emergency brake assist	•
Electronic stability control – ESC	•
WHEELS AND TYRES	
Rims	19"
Standard tyres size	245/35 R19
Tyre inflation kit	•

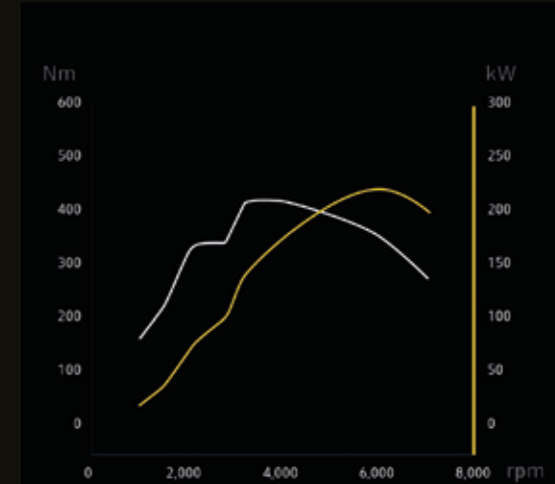

Power : 300 PS/221 kW at 6,000 rpm  
Max. Torque: 420 Nm at 3,200 rpm





## Equipment

	R.S. 300 TROPHY EDC AT
<b>RENAULT SPORT TECHNOLOGIES</b>	
4CONTROL four-wheel steering system	●
4 hydraulic compression stops	●
Cup chassis with Torsen limited slip differential, Brembo® brake calipers, custom springs/shock absorbers	●
R.S. Drive activation button	●
R.S. Drive modes (choice of driving modes - 4 driving modes including Race mode)	●
Launch Control standing start system	●
Multi-change down (advanced downshift system)	●
Aluminium steering wheel shift paddle	●
Bi-material brakes with aluminium bowl	●

<b>EXTERIOR DESIGN</b>	
R.S. extended front wheel arches with air grilles and Renault Sport marking	●
R.S. extended rear wheel arches	●
Custom front bumper widened with F1 style Gun Metal Grey blade, honeycomb front grille with R.S. marking	●
Custom rear bumper widened with functional diffuser and central exhaust	●
R.S. sills/skirt with flat bottom effect	●
R.S. rear spoiler	●
Rear LED 3D Edge Light daytime running lights, always on	●
Daytime running lights with LED light guides and 3D effect	●
19" JEREZ Diamond-cut alloy wheel with red inserts	●
Chrome window weatherstrips	●
Chrome strip on door handles	●
R.S. VISION Full LED 3 function headlights (fog, cornering, long range)	●
PURE VISION Full LED front headlights with integrated C-Shape turn signal	●
Diamond Black door mirrors	●
Renault Sport welcome sequence upon opening the vehicle, with brand light	●
Welcome sequence when approaching the vehicle with brand light lighting, ground lighting and light ambience	●

<b>INTERIOR DESIGN</b>	
Custom R.S. black harmony roof ceiling	●
Chrome-plated Renault Sport front door sills	●
Front centre storage console with armrest	●
Aluminium pedal unit and footrest	●
Dark carbon R.S. fabric upholstery and red contrast stitching	●
R.S. sports seats with integrated headrests	●
R.S. Leather and Alcantara steering wheel with R.S. airbag cover	●
Height and reach-adjustable steering wheel	●
R.S. dashboard and door moulding	●
High centre console with cup holder and closure flap	●

## Equipment

	R.S. 300 TROPHY EDC AT
<b>COMFORT</b>	
Height-adjustable rear headrests	●
1/3-2/3 folding rear bench seat	●
Rain and light sensors	●
Hands-free Renault Key Card with remote locking	●
Dual-zone automatic heating and air conditioning system with toxicity sensor and air recycling	●
Front and rear LED ceiling lights	●
Electrochrome interior rear-view mirror	●
Electrically folding door mirrors	●
Driver's seat with lumbar adjustment	●
Height-adjustable driver's seat	●
Height-adjustable passenger seat	●

<b>MULTIMEDIA</b>	
12V sockets - front and rear	●
EASY LINK 7" touchscreen with FM tuner, 4x USB, Bluetooth, smartphone integration with Apple Carplay / Android Auto	●

<b>SAFETY</b>	
Driver and passenger adaptive front airbags (passenger airbag can be disabled)	●
Lateral chest-level side airbags for driver and front-seat passenger	●
Front and rear curtain head airbags	●
Automatic full central locking when in motion	●
ESC Electronic stability control and ABS with emergency brake assist	●
LED indicators integrated into the door mirrors	●
ISOFIX attachment system on rear side seats	●
R.S. custom braking system	●

<b>DRIVING SUPPORT SYSTEMS</b>	
Rear parking sensors	●
Rear-view camera	●
Cruise control / speed limiter	●
Hill Start Assist	●
Electronic parking brake	●